

SPIDER 73S FPV RACER - USER MANUAL

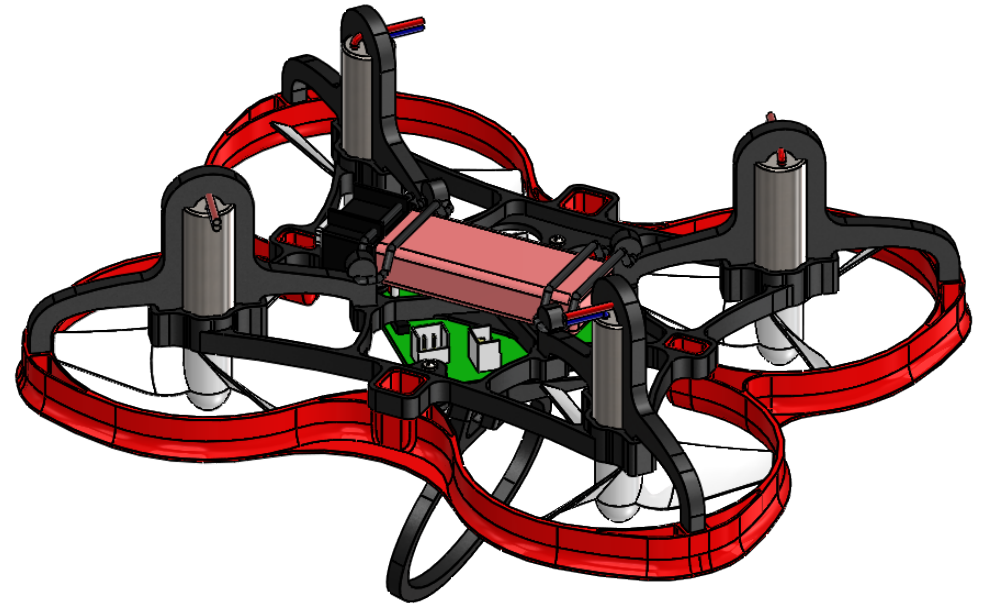
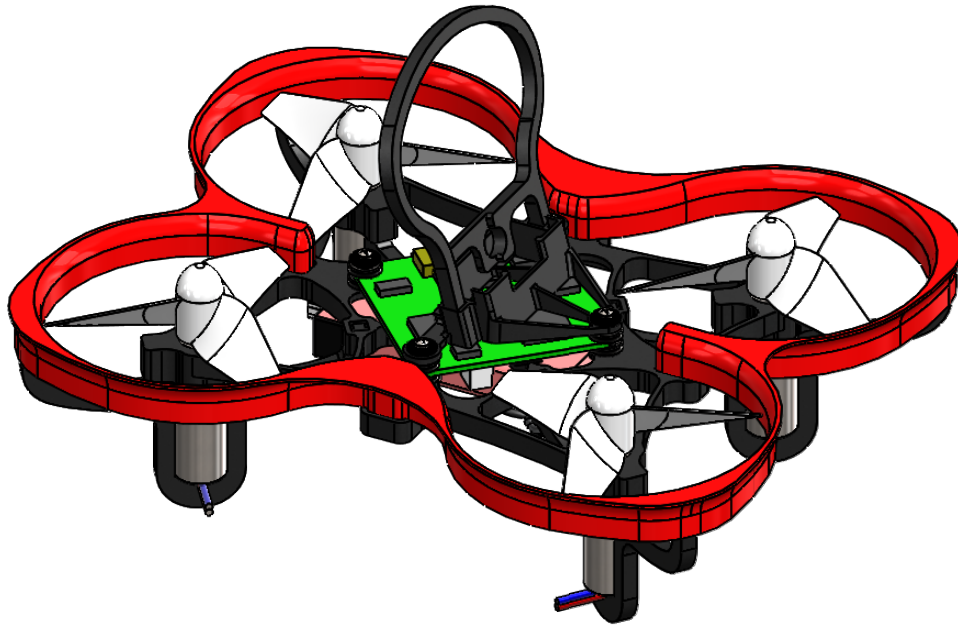

SPECIFICATIONS:

Weight: Frame: 8.8g, total weight with FPV Camera mount: 10g

Materials: Plastic.

Size: 73mm.

Maximum propeller: 40 mm.







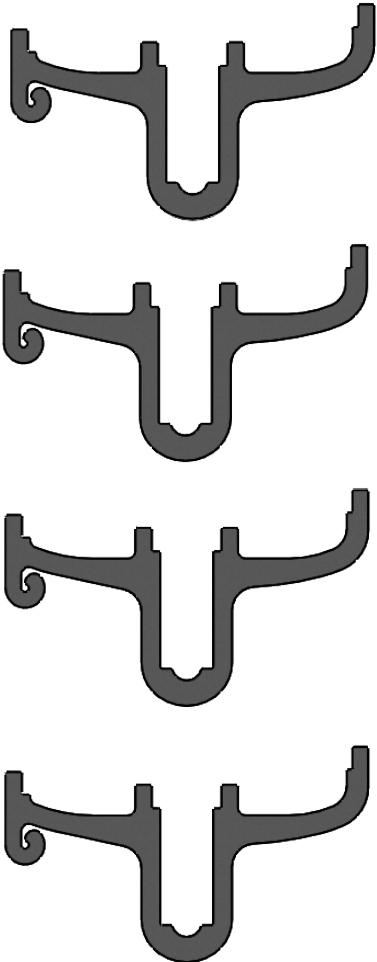

Motor mount: 7x20 mm.

Flight controller mount: 29mm x 29mm.

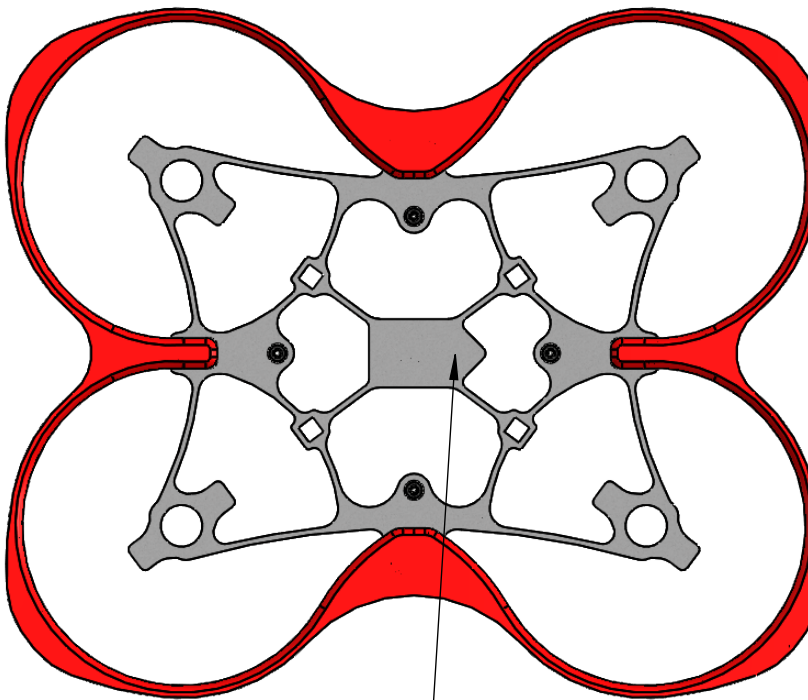
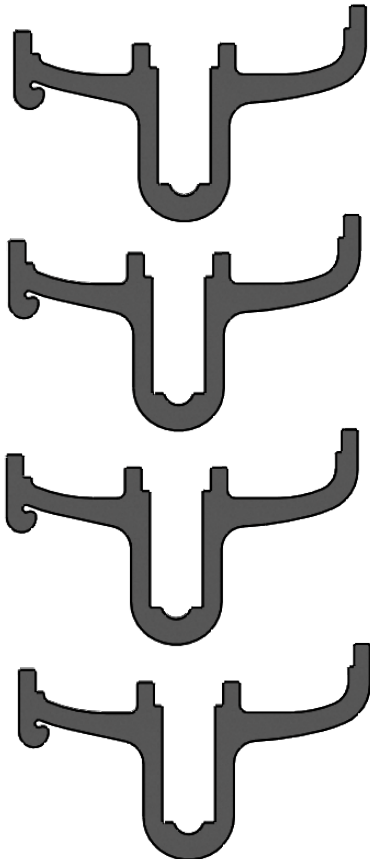
LYNX

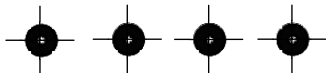
SPIDER 73S FPV RACER - USER MANUAL

PACKAGE LIST PART

 <p>4 x Extra Motor Mount</p>	 <p>15° FPV Camera Mount PTU-Black</p>	 <p>Fly Direction REF</p> <p>Spider 73S-Main Frame Pre-Assembly with Shourd and FC Mount</p>	 <p>4 x Motor Mount</p>
 <p>2 x O-Ring ID 12-W 1</p>	 <p>4 x Washer</p>  <p>4 x M1x3</p>		 <p>2 x O-Ring ID 12 - W 1</p> 

SPIDER 73S FPV RACER - USER MANUAL

Step 01: Motor Assembly

4 x Motor 7x20 mm

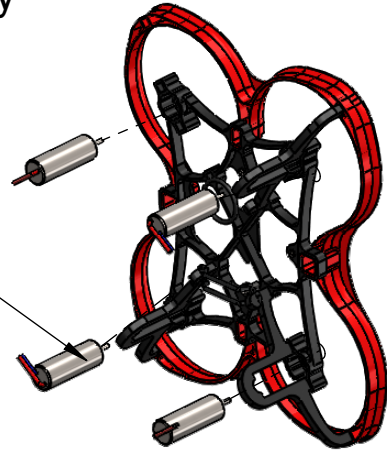

Note: Rotate Motor in order Electric Wire will follow the arrow, as shown

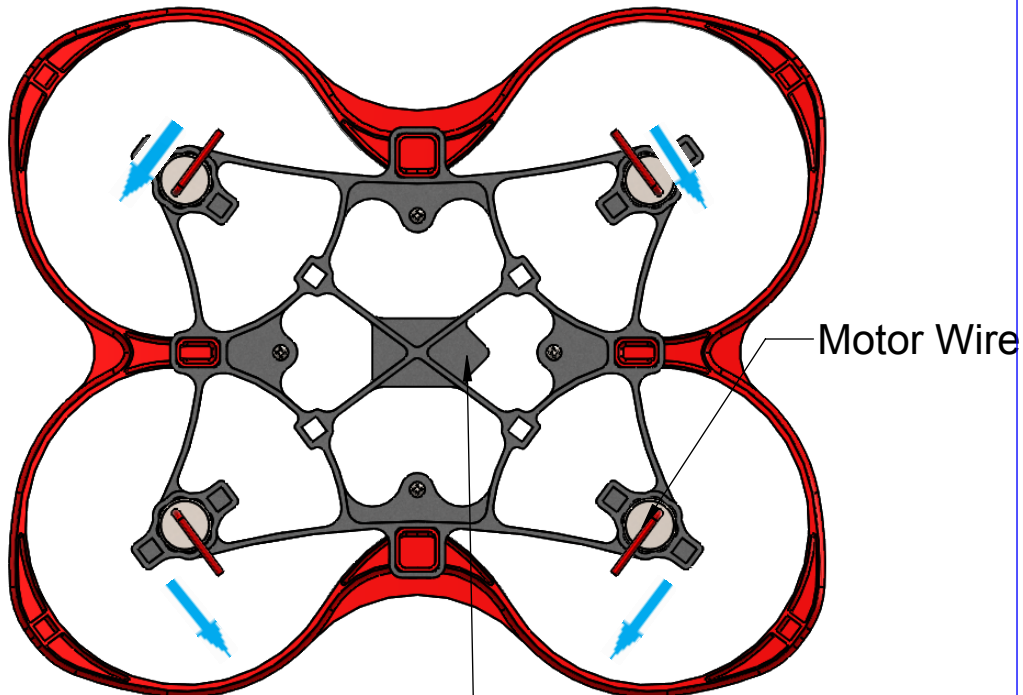

Fly Direction REF

Bottom View

Step 02: Motor Mount Assembly

Normal Motor Mount
(Use Extra Motor Mount for bigger Battery,
Eflite 300mAh/500mAh suggest)

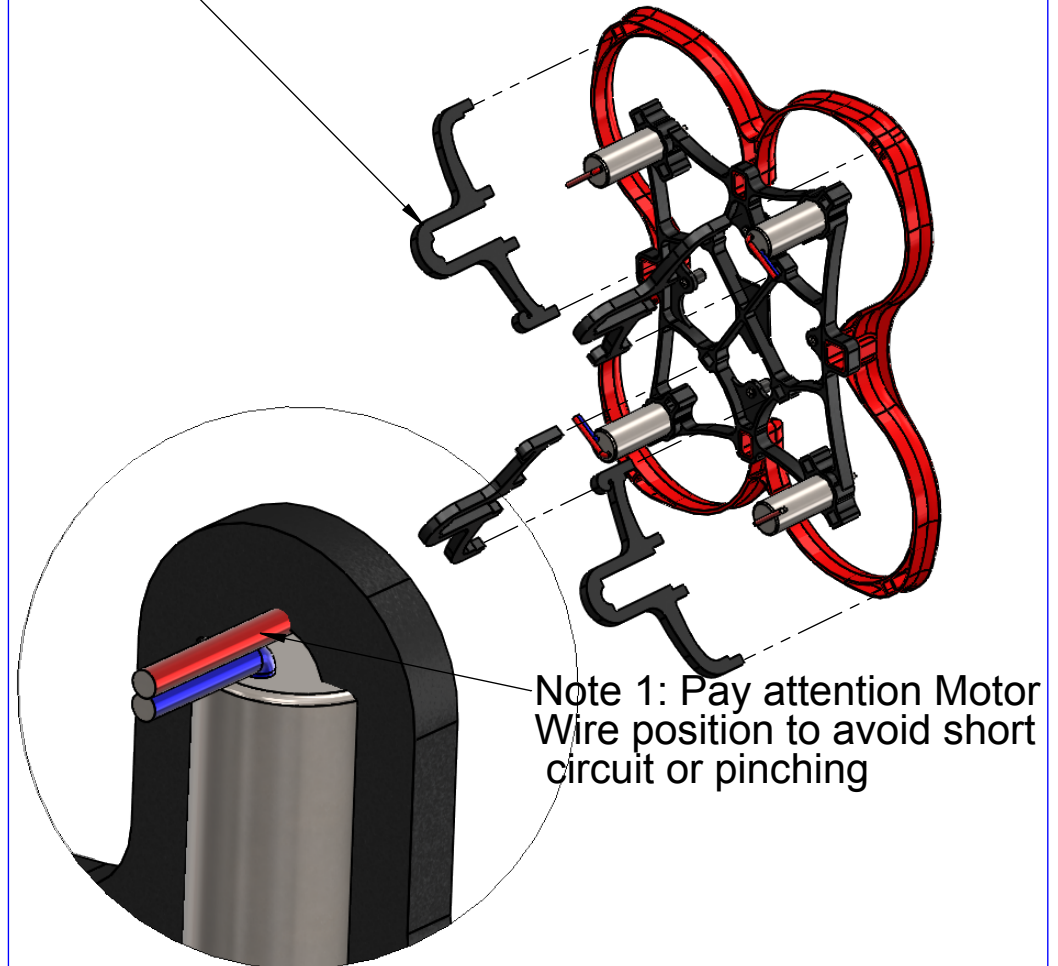

Note 2: Carefully press fit all 16 Motor Mount pins into Frame sockets

LYNX

SPIDER 73S FPV RACER - USER MANUAL

Step 03: Flight Control Assembly

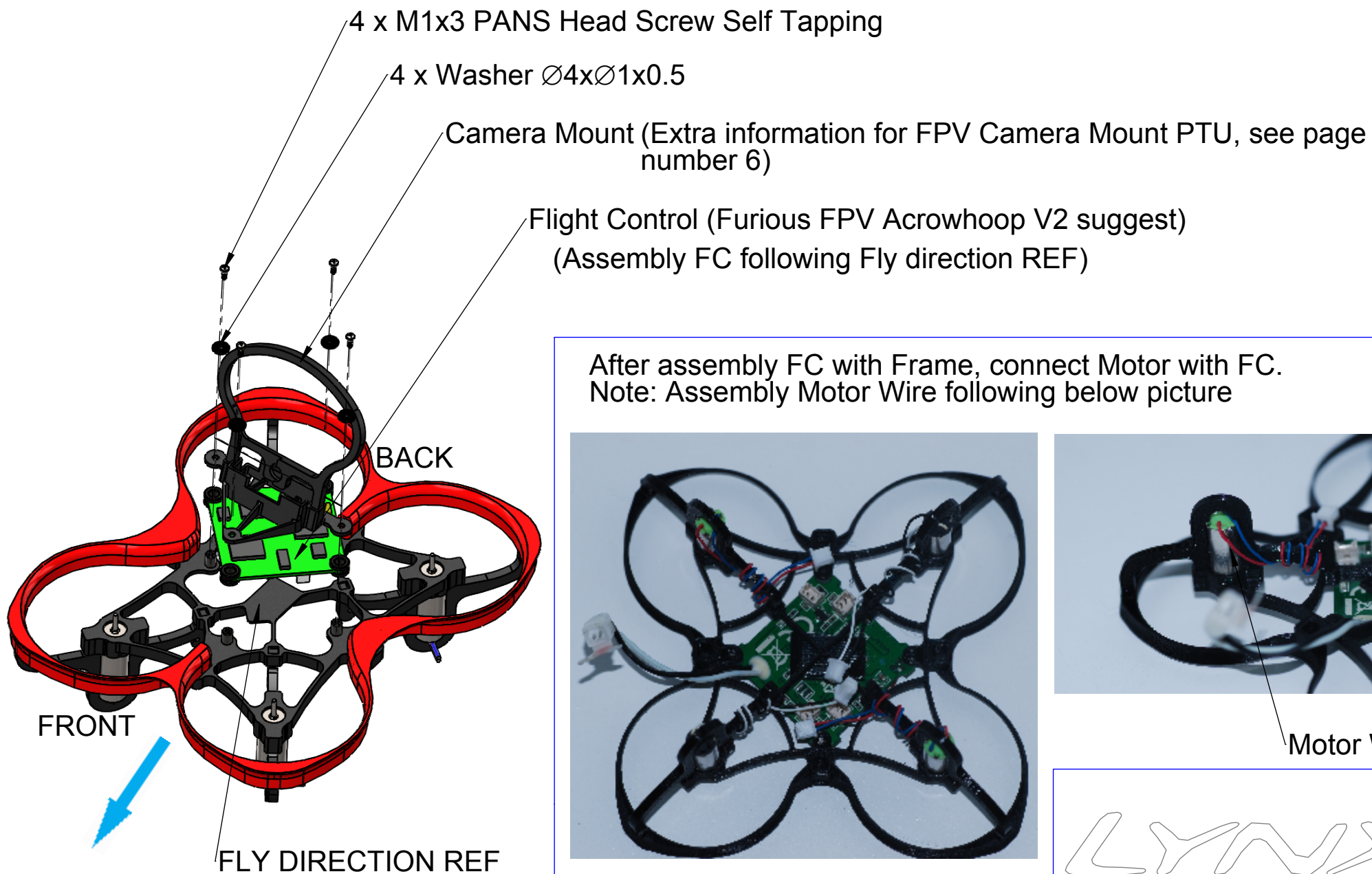

After assembly FC with Frame, connect Motor with FC.
Note: Assembly Motor Wire following below picture

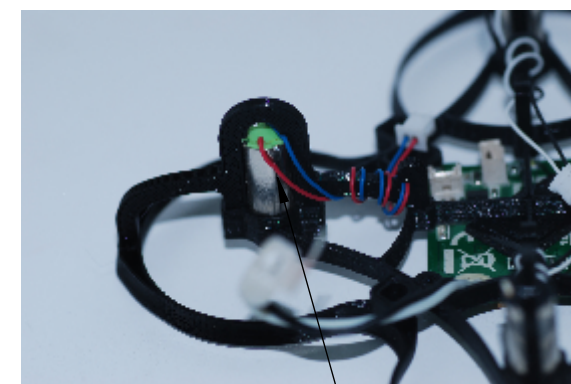

Motor Wire

LYNX

SPIDER 73S FPV RACER - USER MANUAL

Step 04: O-Ring Battery Support Assembly

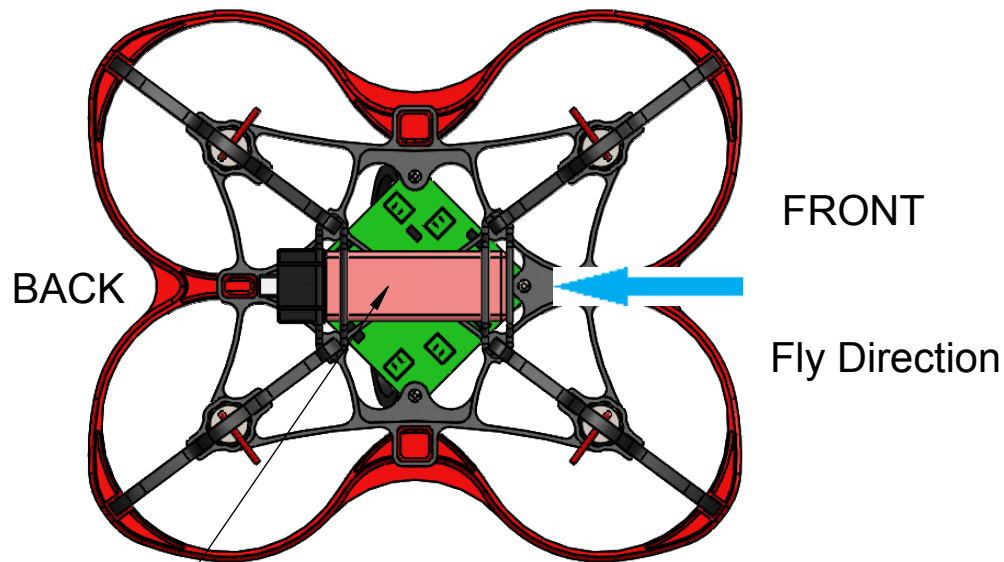
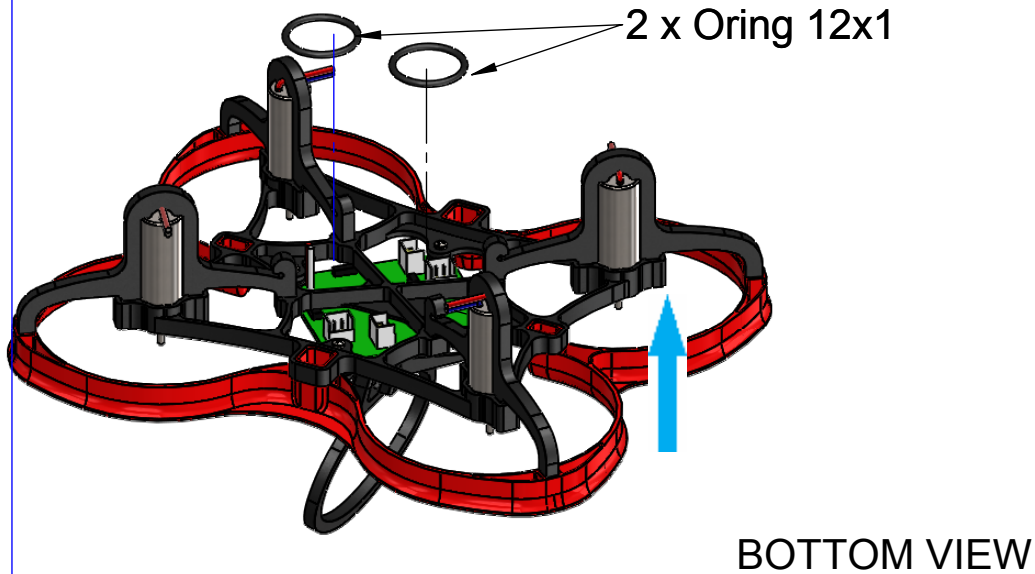

Battery (PULSE 300mAh 1S 3.7V 30C / Eflite 300mAh/500mAh suggest)

Step 05: Propeller Assembly

2 x CW propeller
2 x CCW propeller

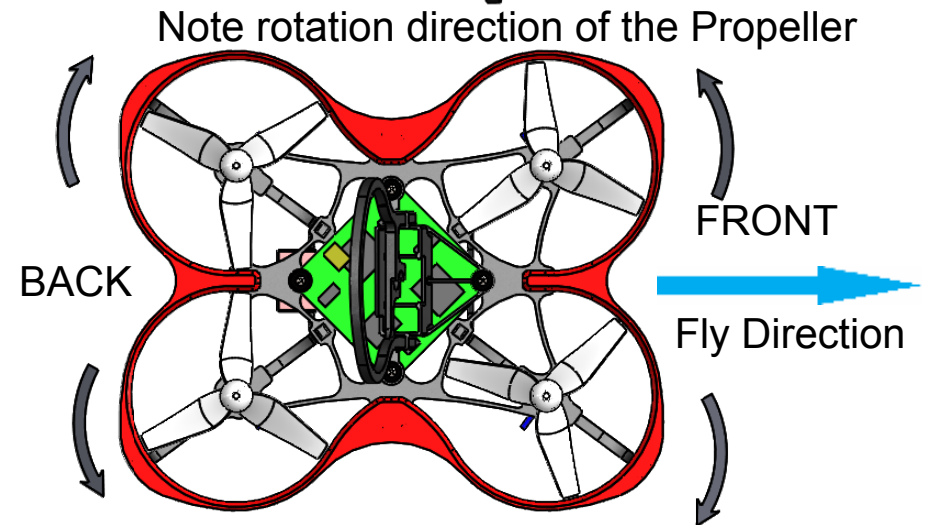
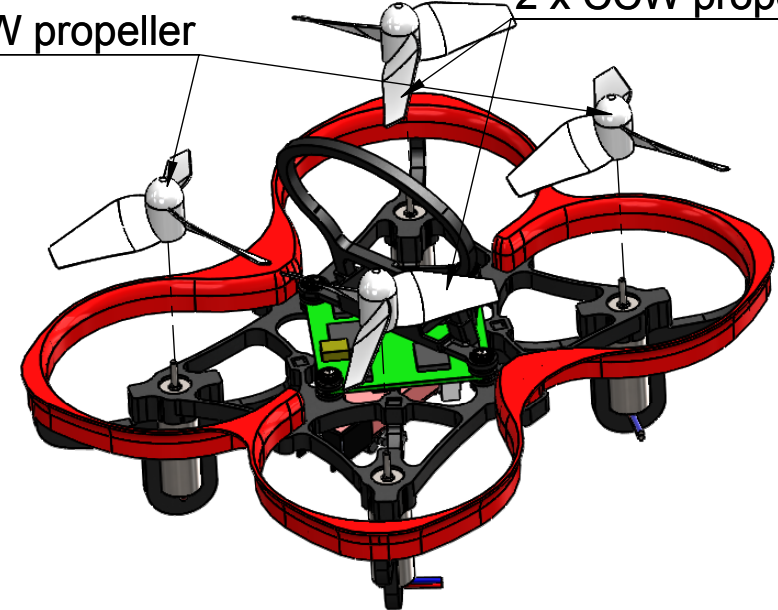

LYNX

Inductrix FPV Rollbar Camera Mount TPU - 7/15/20 deg Set - V2 - Manual

Step 01: Insert Camera into Camera Mount

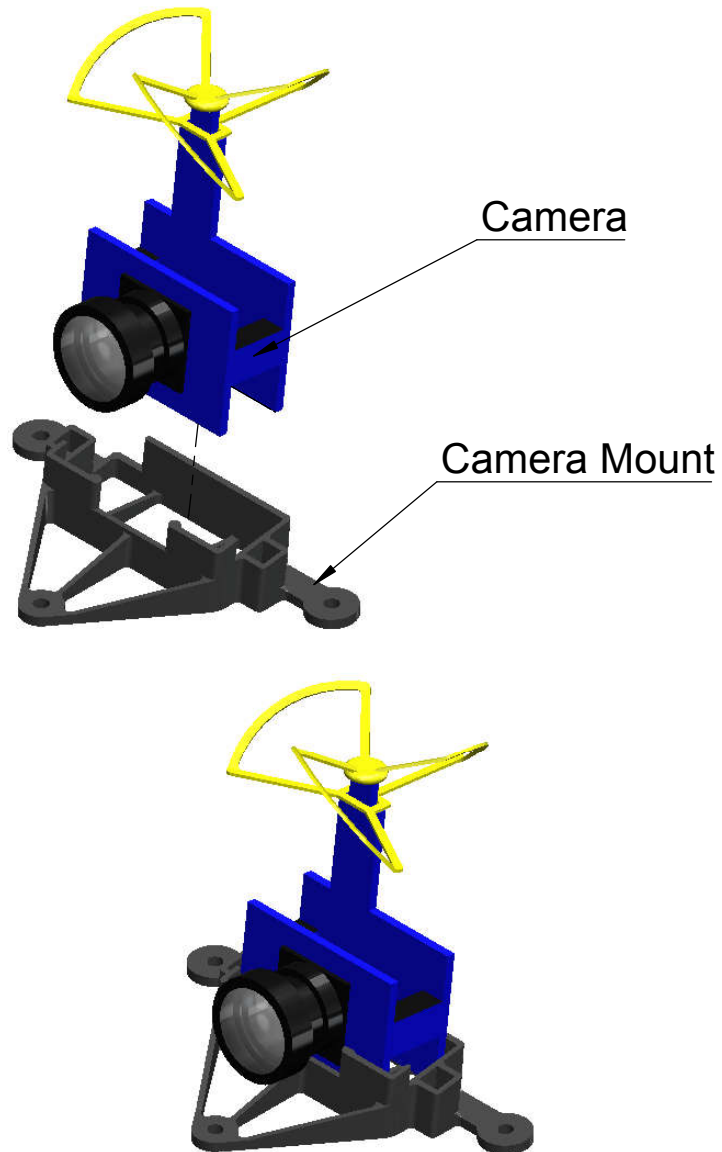

Step 02: Insert Roll Bar into Step 01, press fit Roll Bar into Camera Mount socket (as shown)

